

Racking-up credits!



Our consistent growth is testament of our capabilities...

415 Pon Yi Rd, Tai Ping, Taichung, Taiwan. R.O.C

T 886 4 2278 6468

F 886 4 2270 3782

E info@chengchia.com.tw



www.chengchia.com.tw

CHENG CHIA

 **CHENG CHIA INDUSTRIAL CO., LTD.**
www.chengchia.com.tw



Design and manufacture of a variety of show racks for commodities.



Our consistent growth is testament of our capabilities...

From large surface hypermarkets to fashionable music stores, Cheng Chia display racks have found their rightful place in international retail markets around the world. Providing secure and easy fastening, these product display racks help create interest in places that normally go unnoticed. With a splendid selection, Cheng Chia Racking Systems have been developed to suit individual retail needs, be it through form, function and/or material.

→ Cheng Chia has developed product stands, display racks, stocking racks, magazine & promotional literature racks, shelving, basket racks and other store fixtures for multiple retail store types and space usage optimization.

Company Introduction

Cheng Chia Industrial Co., was established in 1976. Both the company's main office and factory are located in Tai Ping, Taichung, Taiwan. Cheng Chia's areas of specialism are the design and manufacture of a range of show racks for the food industry hardware goods, art artifacts displays, household appliances, stationery, books and many others.



Japanese-manufactured computer-controlled Bending Machine: Produces smooth and accurate curves.



Automatic Computer-Controlled Shearing Machine



Double-welding Semi-automatic Computer Spot Welding Machine: With the welding spot exerting fast and steady pressure, the girt strip is leveled for maximum smoothness after fast welding.

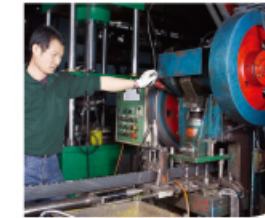

Automatic Punching Machine: full automatic support, with fixed-size compartments between punched holes 20-m compartment with a tolerance within 0.5m/m

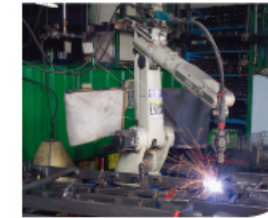

Mechanical-Arm Automatic Welding Machine: Computer controlled welding.



Powder Bake Coating: shown in automatically controlled tunnel





Operation Management

Business is growing fast and the field of operations management is ever changing and improving. With increasing links of transportation the world is getting smaller and smaller. In order to respond to customers' needs and help them increase their profitability, Cheng Chia are constantly seeking to improve and create new products.

Kevin Wang, President of Cheng Chia Industrial Co. Ltd., says that the company's operation management policy is centered around the core values of quality and service.

- **With** more than three decades of servicing the industry, Cheng Chia can rely on years of experience to support its clients through each process, from production to shipment.
- **In fact**, there is very little Cheng Chia doesn't do. As an integral part of the business' structure, Cheng Chia implements a Customer Service System which leaves nothing unattended; short lead-time OEM and ODM solutions, unique customized designs, rapid mock-up sample fabrication and shipping logistics. These services give the clients freedom to request intricate designs whatever the size, colour and style they may need.
- **It is** the very idea that each and every one of Cheng Chia's clients should get unparalleled attention and personal assistance in all business related matters that has enabled the company to grow every year.



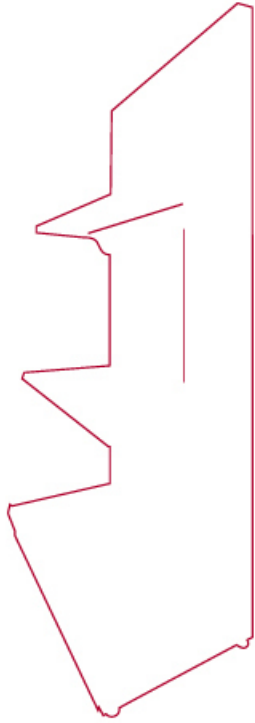

CHENG CHIA
Product catalogue



C series	08
NC series	22
CH series	38
Storage rack	52
Promotion type	58
Custom made	62

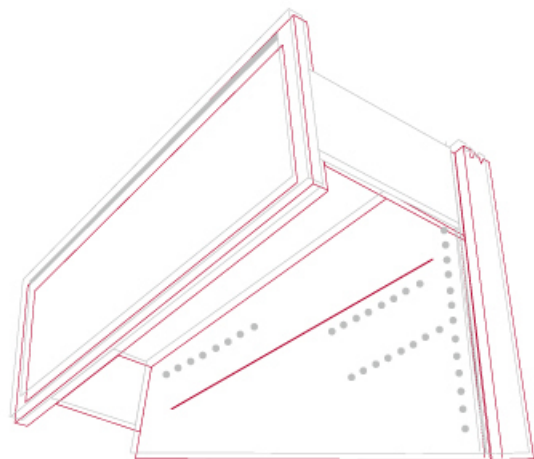

CHENG CHIA
Product catalogue

C series



C SERIES Light Duty Display Rack

This highly economical display rack may be used for either hanging or flat displays. It is attractive, easy to assemble, and very safe and stable. It can be set up in many different arrangements. This is currently one of Cheng Chia's most popular display racks.

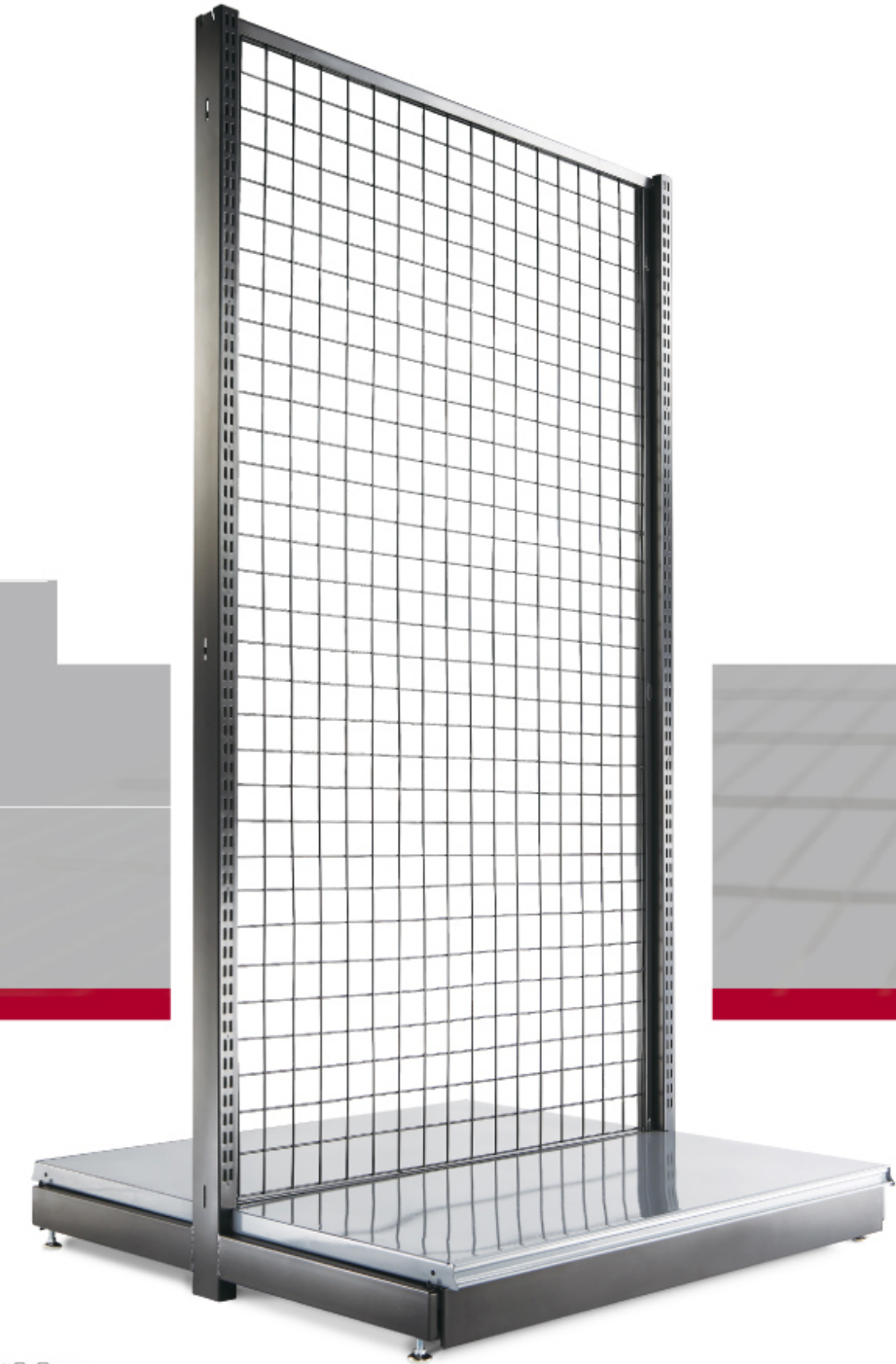
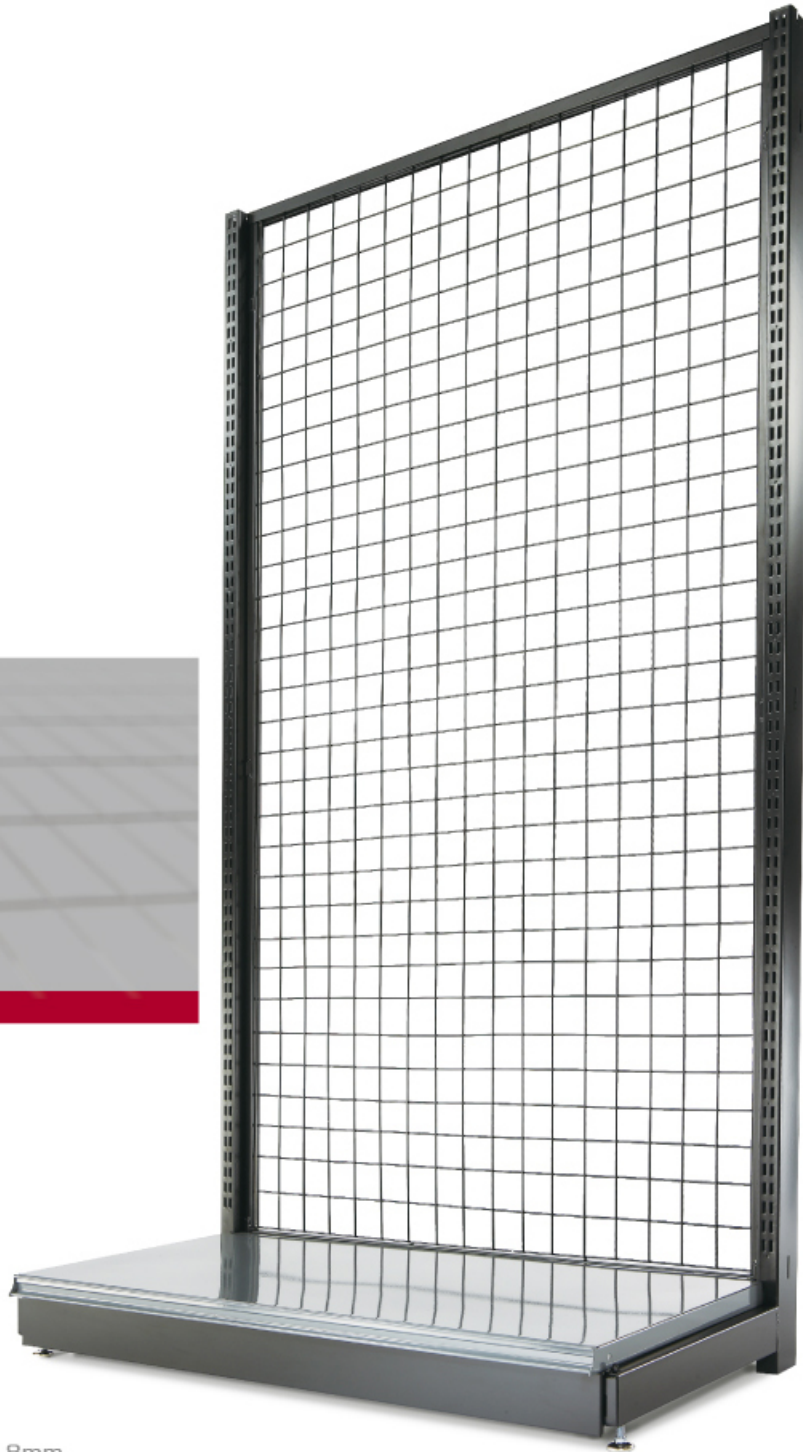

C-203

Size:
H: 1420, 1510, 1800, 2100, 2400mm
W: 700, 945, 1000, 1245mm (Single Unit)
W: 685, 930, 985, 1230mm (Conjoin Unit)
D: 450mm

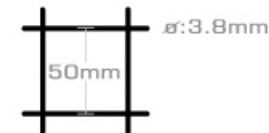

C-201

Size:
H: 1420, 1510, 1800, 2100, 2400mm
W: 700, 945, 1000, 1245mm (Single Unit)
W: 685, 930, 985, 1230mm (Conjoin Unit)
D: 900mm

C-Series; Light Duty: Shelves and cabinets

This display rack is so versatile that shelves can be assembled at different heights and angles and large multiple function storage cabinets sit perfectly on the rack base. Our attractive storage cabinets are built to withstand heavy weights and come in different shapes and sizes.

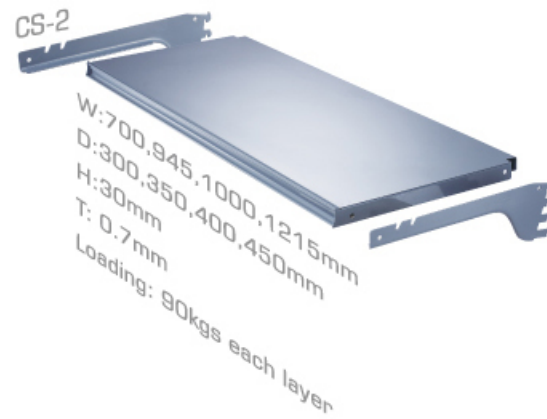

CS-2
W: 700, 945, 1000, 1245mm
D: 300, 350, 400, 450mm
H: 30mm
T: 0.7mm
Loading: 80kgs each layer



CB-1
Size:
W: 700, 945, 1000, 1245mm
D: 450mm
H: 500mm

CB-2
Size:
W: 700, 945, 1000, 1245mm
D: 450mm
H: 500mm

C-Series: light Duty: Logo panels

These display racks are suitable for a number of promotional and product displaying functions. And to highlight the product types or product brands, Cheng Chia offers a practical range of Logo panels to suit individual requirements and preferences.

Slot-in logo panel

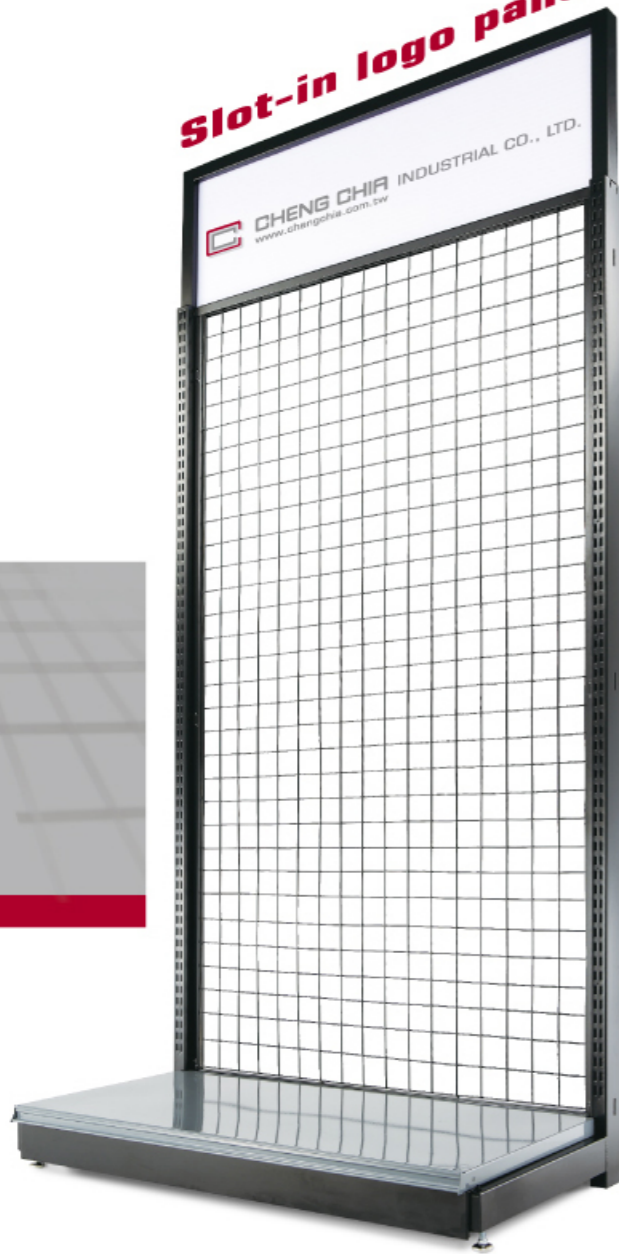

C-L08
→ Size:
W: 700, 945, 1000, 1245mm
H: 300mm
D: 60mm

Poster Style Logo Panel



C-L12
→ Size:
W: 700, 945, 1000, 1245mm
H: 200, 300, 350, 400mm

Pop Out Logo Panel

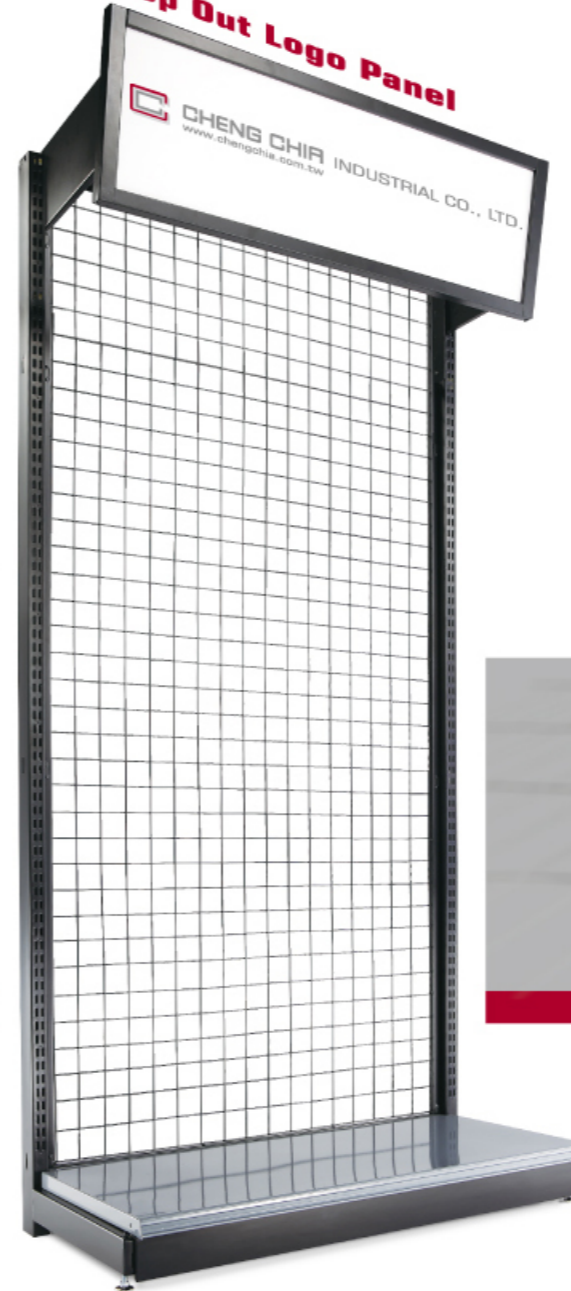

C-L13
→ Size:
W: 700, 945, 1000, 1245mm
H: 300mm

Arc Style Logo Panel

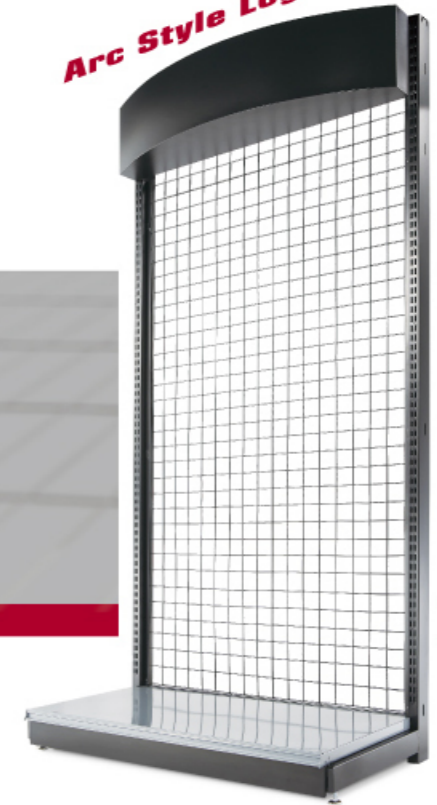

C-L15
→ Size:
W: 700, 945, 1000, 1245mm
H: 210mm
D: 200mm

C-Series: light Duty: light boxes

This range would not be complete if it weren't for Cheng Chia's Logo light box series. These come in different thicknesses and help illuminate the product and/or brand name, making them noticeable in crowded places. Colors become vibrant and the display rack stands out from others.

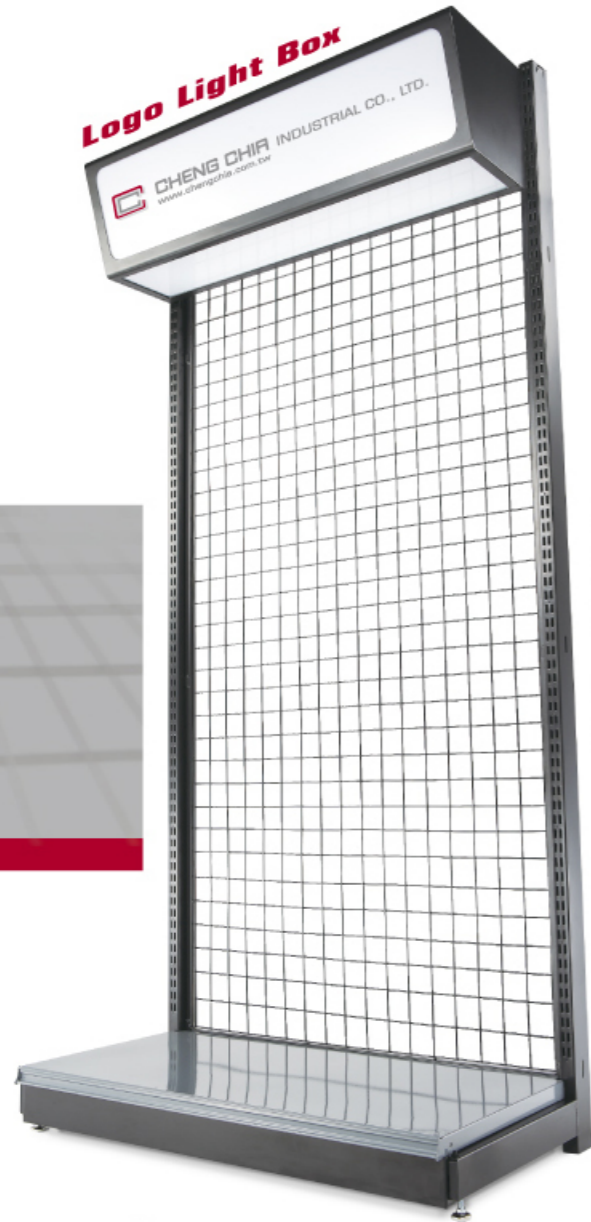

C-L10
 Size:
 W: 700, 945, 1000, 1245mm
 H: 250mm
 D: 270mm



C-L17
 Size:
 W: 700, 945, 1000, 1245mm
 H:
 D: 60mm

Accessories

C-925



Size:
 ø: 3.8mm
 L: 50, 100, 150, 200, 250, 300mm

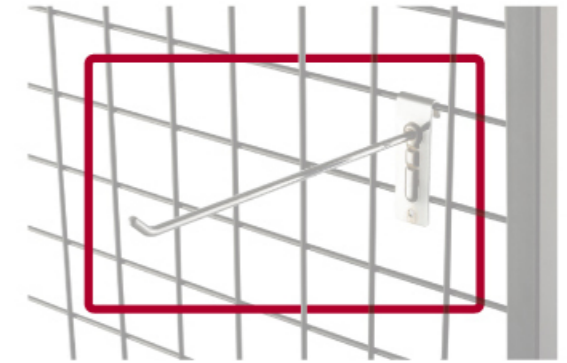

All hooks are available with electro-plated or enamel finish. We welcome requests for custom hook styles and dimensions.

C-928



Price Tag : w 40, 70mm



Size:
 ø: 6mm
 L: 100, 150, 200, 250, 300mm

C-929



Size:
 L: 300mm Price Tag : w 40, 70mm

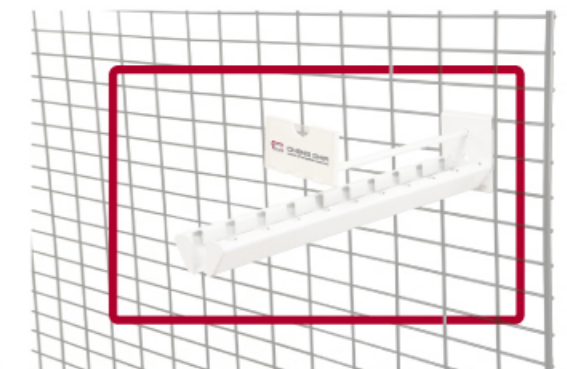

All hooks are available with electro-plated or enamel finish. We welcome requests for custom hook styles and dimensions.

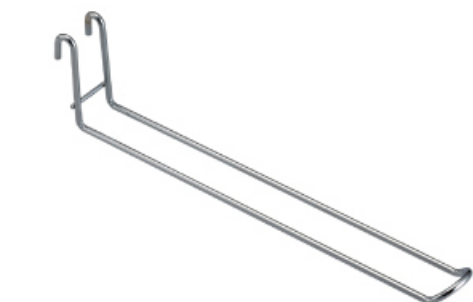
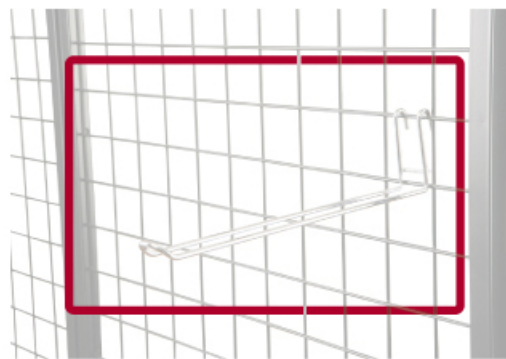

C-915

Size:
 \varnothing : 3.8mm
 L: 50, 100, 150, 200, 250, 300mm



C-934

Size:
 T: 1.2mm
 D: 300, 350, 400, 450

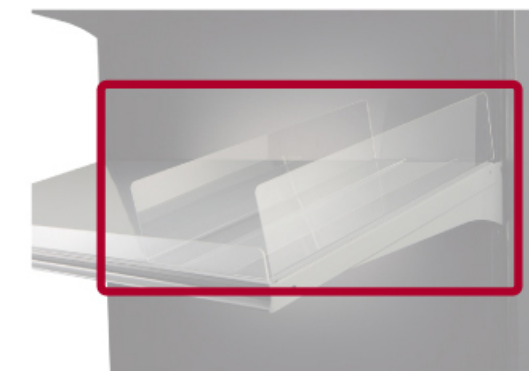

C-917

Size:
 W: 700, 945, 1000, 1245mm
 H: 60mm



Price Label

C-918

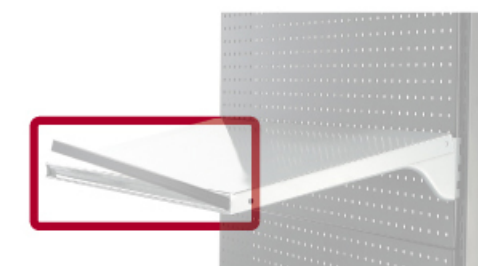

Size:
 W: 700, 945, 1000, 1245mm



C-933



Size:
 W: 700, 945, 1000, 1245mm
 H: 40mm

C-900



Size:
 TUBE: T1.2x20x20mm
 D: 300, 400mm



All hooks are available with electro-plated or enamel finish. We welcome requests for custom hook styles and dimensions.

C-923



Size:
TUBE: T1.2x20x20mm
D: 300, 400mm

C-922



Size:
D: 400

C-926

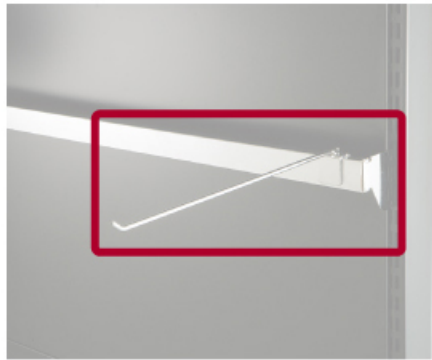

Size:
ø: 6mm
L: 50, 100, 150, 200, 250, 300mm

C-921

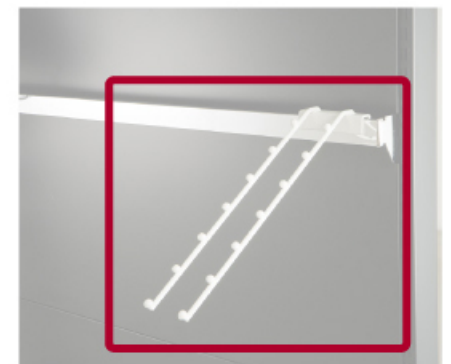

Size:
D: 400

C-930



Size:
ø: 4.8mm
L: 100, 200, 300mm
Price Tag : w 40, 70mm



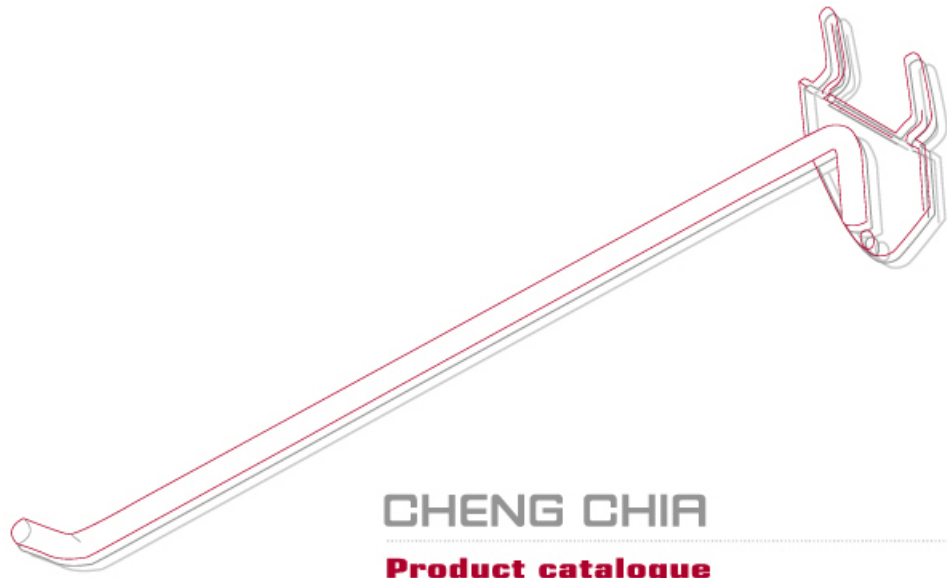

CHENG CHIA
Product catalogue

NC series



NC SERIES Medium Duty Display Rack

With a pegboard panel, this display rack can be used for hanging hardware items and can display a wide variety of products. Moveable shelves can also be hung from the rack. Shelves can be mounted flat or at an angle to create attractive thematic displays. The base is detachable and the back panel is easy to assemble. This rack has the biggest capacity and is highly suitable for high-end stores or exhibitions.

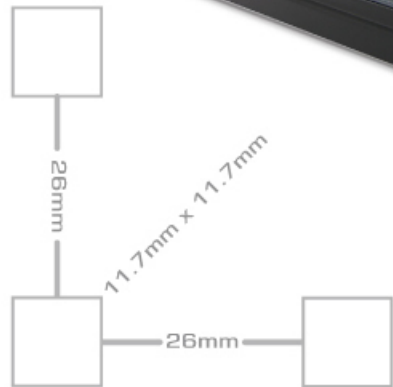
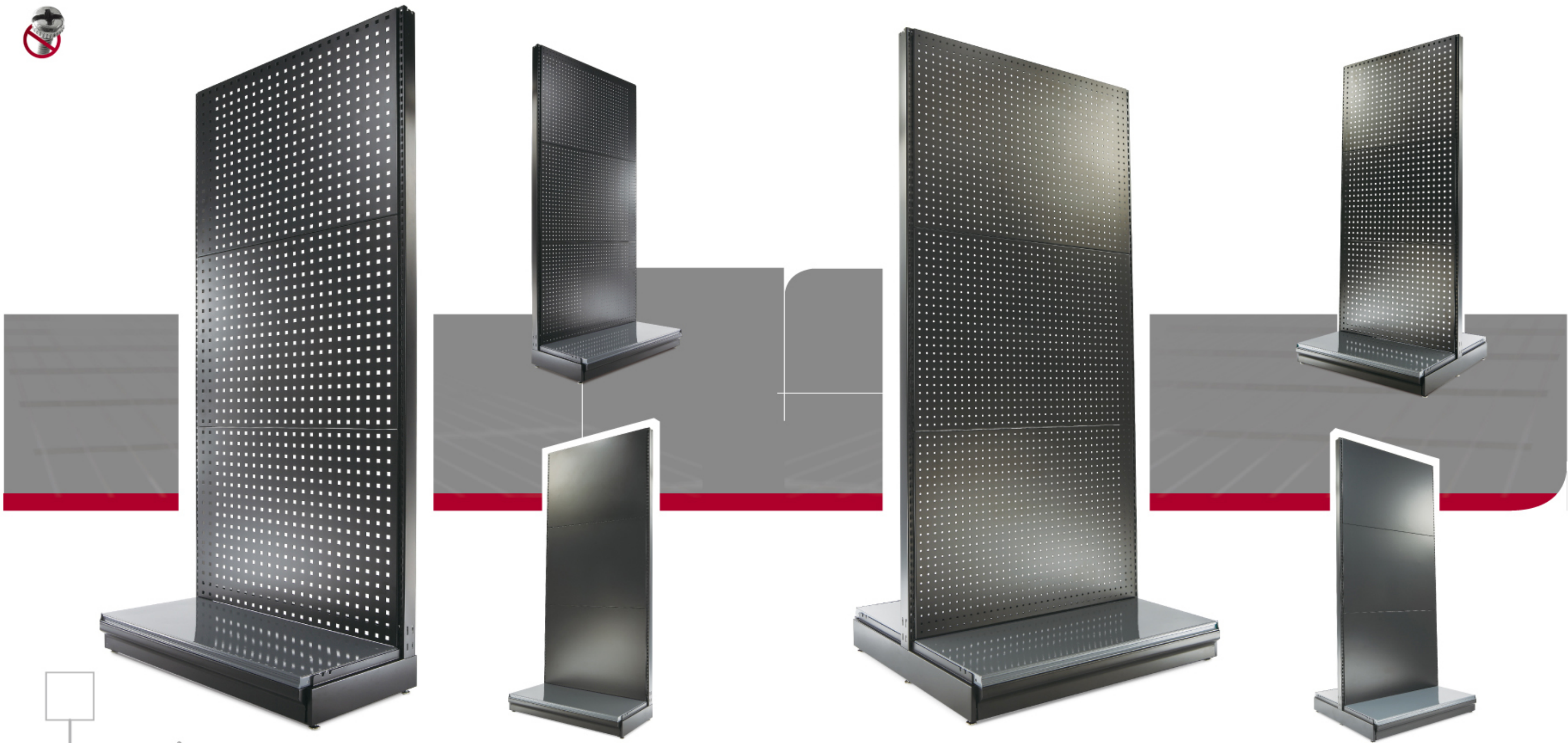

NC-070

Size:
 H: 1420, 1510, 1770, 2070, 2370mm
 W: 700, 945, 1000, 1245mm (Single Unit)
 W: 685, 930, 985, 1230mm (Conjoin Unit)
 D: 450, 500, 600mm

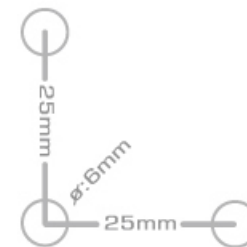

NC-050

Size:
 H: 1420, 1510, 1770, 2070, 2370mm
 W: 700, 945, 1000, 1245mm (Single Unit)
 W: 685, 930, 985, 1230mm (Conjoin Unit)
 D: 4900, 1000, 1200mm

NC-Series; Medium Duty: Shelves and cabinets

This display rack is so versatile that shelves can be assembled at different heights and angles and large multiple function storage cabinets sit perfectly on the rack base. Our attractive storage cabinets are built to withstand heavy weights and come in different shapes and sizes.

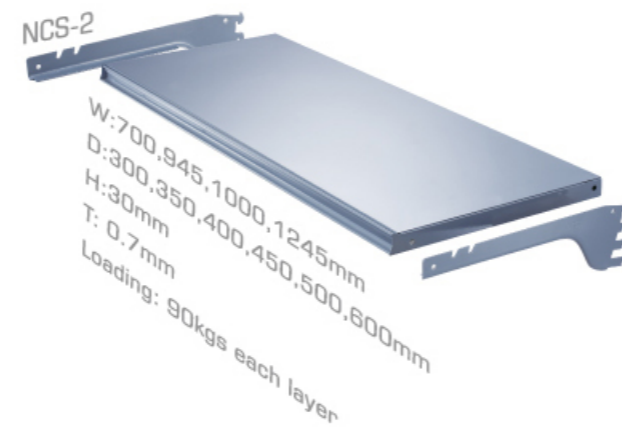

NCB-1
Size:
W: 700, 945, 1000, 1245mm
D: 450, 500, 600mm
H: 500mm



NCB-2
Size:
W: 700, 945, 1000, 1245mm
D: 450, 500, 600mm
H: 500mm

NC-Series; Medium Duty: Shelves and lighting shelves

In order to provide adaptable systems for a variety of retail needs, Cheng Chia has gone beyond normal metal shelves and has developed a variety of original shelf features to enhance product display and brand recognition.



Socket Shelf

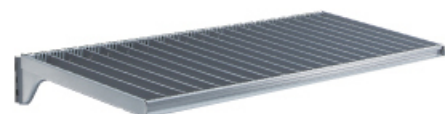

NCS-3
 Size:
 W: 700, 945, 1000, 1245mm
 D: 380mm
 H: 30mm



Glass Shelf Set



NCS-4
 Size:
 W: 700, 945, 1000, 1245mm
 D: 300mm



Lighting Shelf

NCS-5
 Size:
 W: 700, 945, 1000, 1245mm
 D: 300, 350, 400, 450, 500, 600mm
 H: 30mm

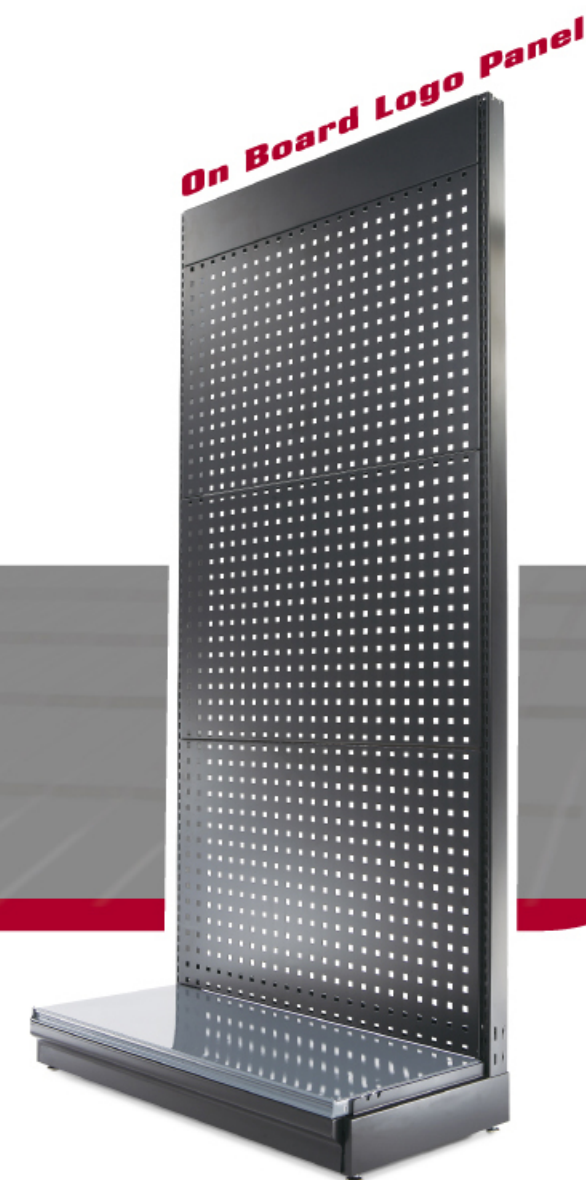

On Board Logo Panel



NC-L18
 Size:
 W: 700, 945, 1000, 1245mm
 H:

NC-Series: Medium Duty: Logo panels

These display racks are suitable for a number of promotional and product displaying functions. And to highlight the product types or product brands, Cheng Chia offers a practical range of Logo panels to suit individual requirements and preferences. From Logo light boxes, slot logo panels to poster style logo panels, Cheng Chia has thought of everything.

Logo Light Box



NC-L10

 Size:
W: 700, 945, 1000, 1245mm
H: 250mm
D: 270mm

Slim Logo Light Box

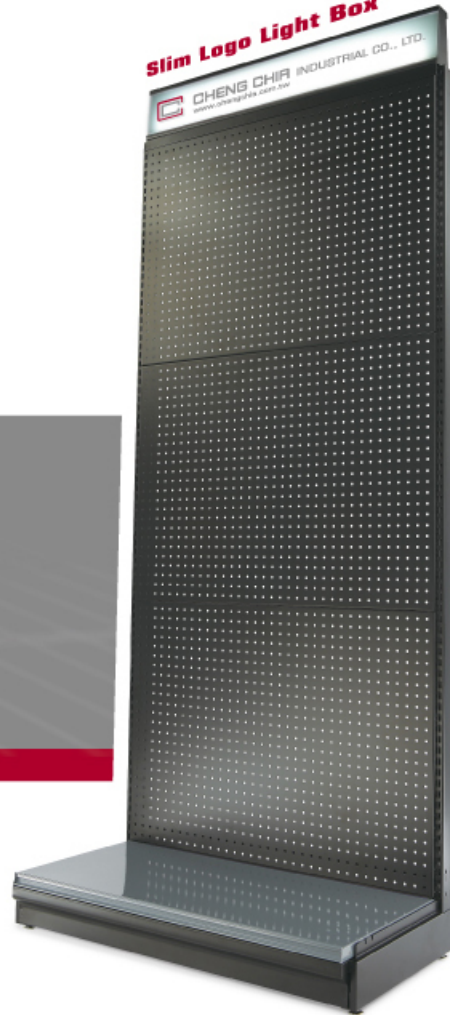

NC-L17

 Size:
W: 700, 945, 1000, 1245mm
H:
D: 60mm

Slot-in logo panel



NC-L08

 Size:
W: 700, 945, 1000, 1245mm
H: 300mm
D: 60mm

Poster Style Logo Panel

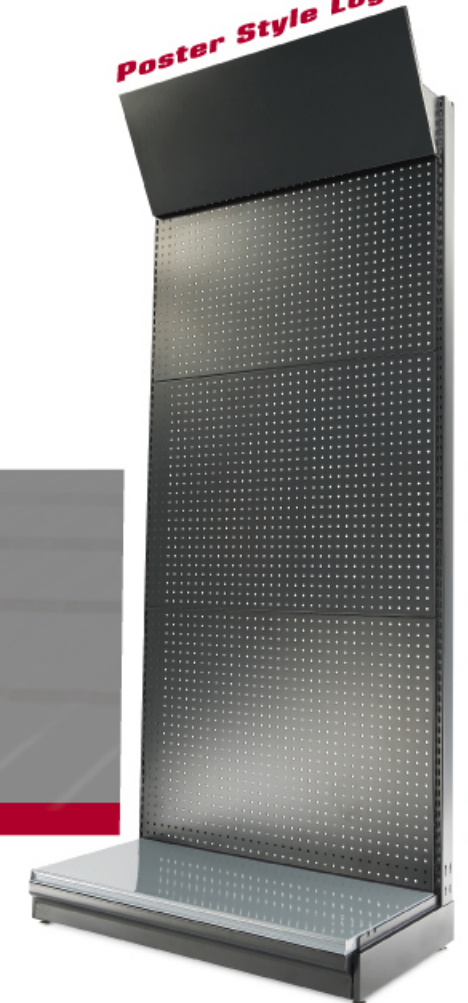

NC-L12

 Size:
W: 700, 945, 1000, 1245mm
H: 200, 300, 350, 400mm

NC-Series: Medium Duty: Customized side panels and Arc style logo panels.

Some brands and branded products require their racking systems to emulate the brand personality and brand design consistency. With this in mind, Cheng Chia is able to provide customized Logo panels and side panel to enhance the display experience.

Accessories

Pop Out Logo Panel

Arc Style Logo Panel

**Customize your side panel
(any shape, size and artwork)**

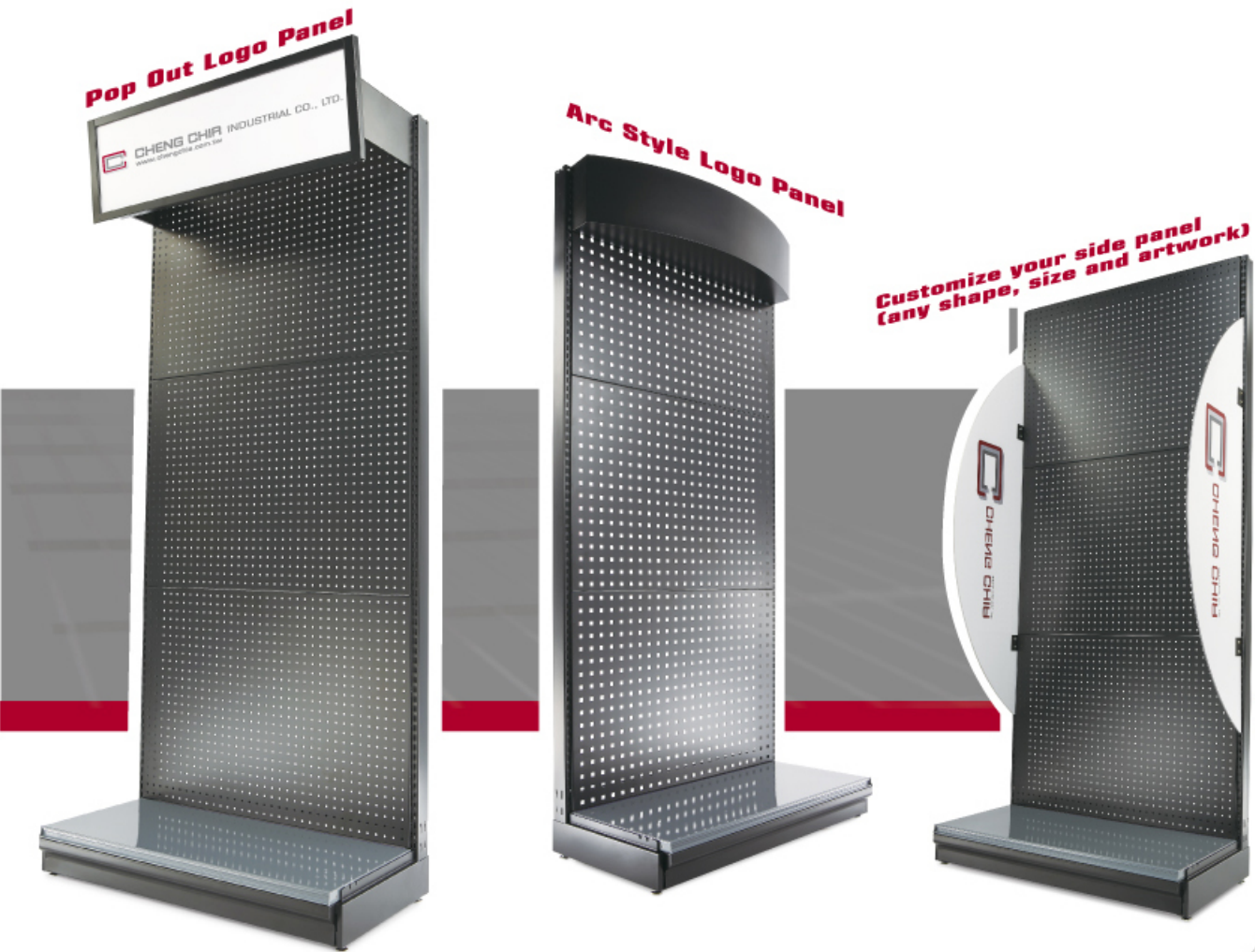

NC-920



Size:
ø: 8mm,6mm,4mm
L:200,300,400mm

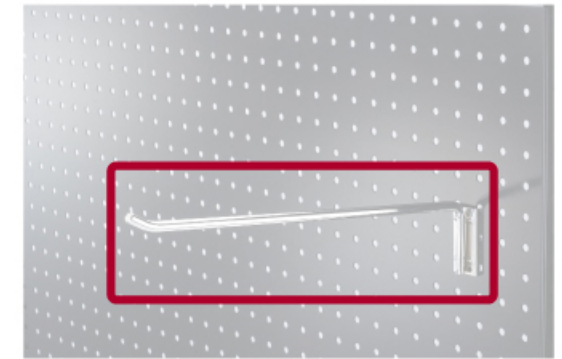

All hooks are available with electro-plated or enamel finish. We welcome requests for custom hook styles and dimensions.

NC-928



Price Tag : w 40, 70mm

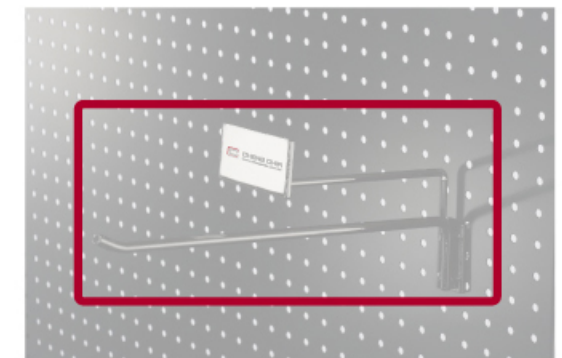

Size:
ø: 8mm,6mm,4mm
L:200,300,400mm

NC-712



Size:
ø: 3.8mm
L:50,100,150,200,250,300mm

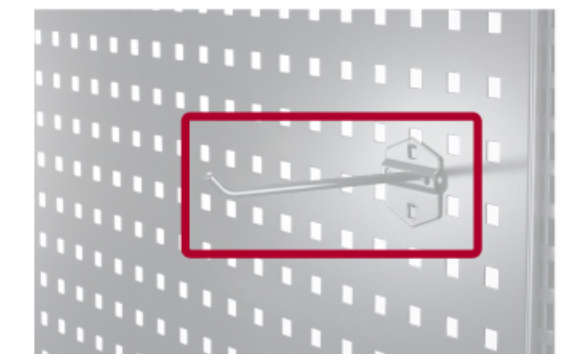

NC-L13
Size:
W:700,945,1000,1245mm
H:300mm



NC-L15
Size:
W:700,945,1000,1245mm
H:210mm
D:200mm

NC-L33
Size:
W:400mm
H:1400mm
T:5.0mm



All hooks are available with electro-plated or enamel finish. We welcome requests for custom hook styles and dimensions.

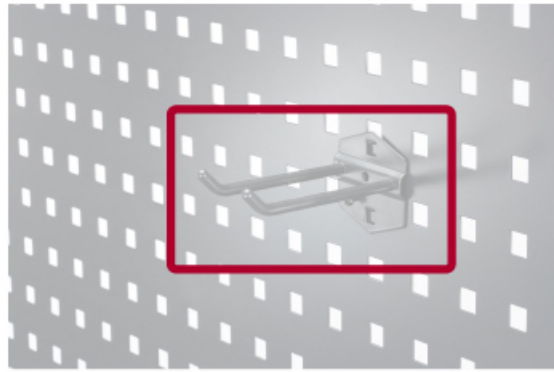

NC-714

Size:
 \varnothing : 3.8mm
 L: 50, 100, 150, 200, 250, 300mm

NC-913

Size:
 \varnothing : 3.8mm
 L: 50, 100, 150, 200, 250, 300mm

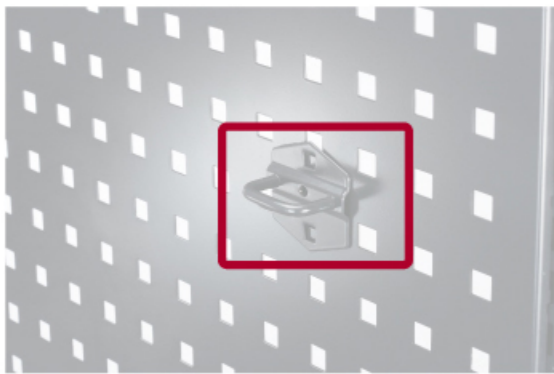

NC-715

NC-713

Size:
 \varnothing : 3.8mm
 L: 50, 100, 150, 200, 250, 300mm

Size:
 \varnothing : 3.8mm
 L: 25.4mm

NC-938

Size:
 \varnothing : 6mm
 L: 150, 200, 300mm

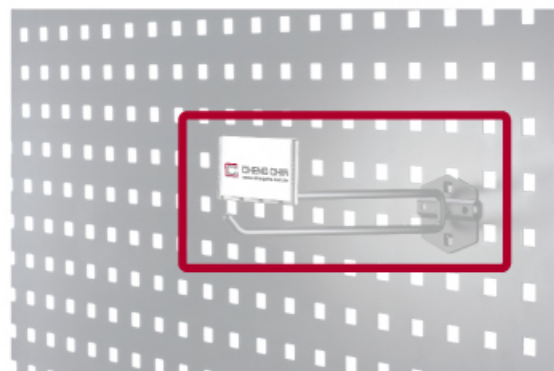

NC-919

Price Tag : w 40, 70mm

Size:
 \varnothing : 6mm
 L: 100, 150, 200, 250, 300mm

NC-900

Size:
 W: 700, 945, 1000, 1245mm

All hooks are available with electro-plated or enamel finish. We welcome requests for custom hook styles and dimensions.



NC-923



Size:
TUBE:T1.2x20x20mm
D:300,400mm

NC-917



Size:
W:700,945,1000,1245mm
H:60mm

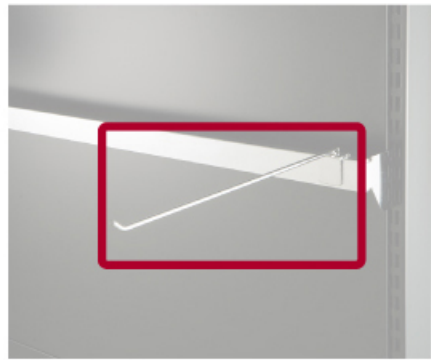

NC-926



Size:
ø: 6mm
L:50,100,150,200,250,300mm



NC-933



Size:
W:700,945,1000,1245mm
H:40mm



NC-930



Price Tag : w 40, 70mm



Size:
ø: 4.8mm
L:100,200,300mm

NC-934



Size:
T:1.2mm
D:300,350,400,450

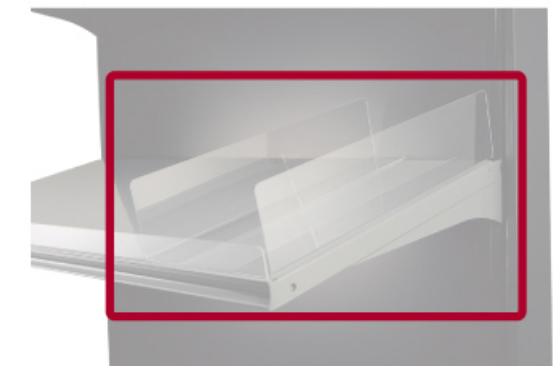

All hooks are available with electro-plated or enamel finish. We welcome requests for custom hook styles and dimensions.

Price Label

NC-918

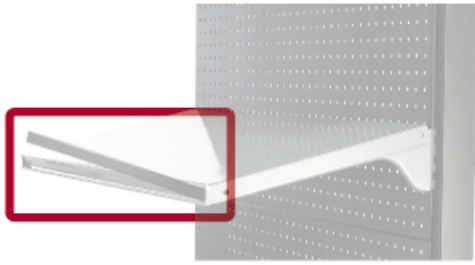

Size:
W:700,945,1000,1245mm

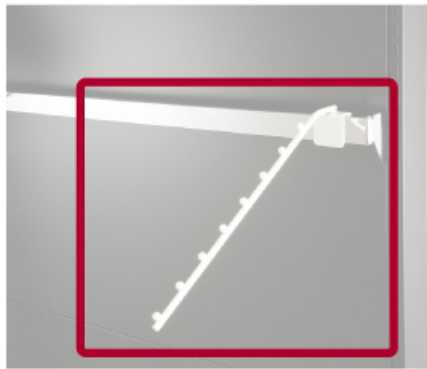

NC-922



Size:
D:400

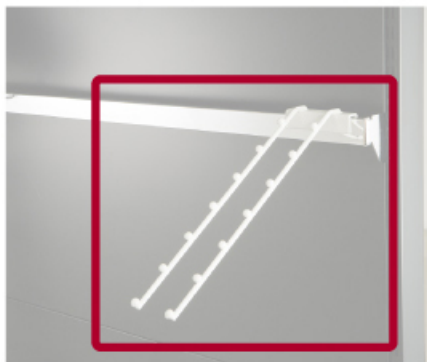

NC-921



Size:
D:400

CH series



CH SERIES Heavy Duty Display Rack

This new heavy duty display rack's most important feature is its use of interchangeable panel types, including pegboard, plain steel, slat wall, translucent acrylic panel, and grid panel. It is ideal for the display of goods in shopping areas where matching components are desirable. This is Cheng Chia's newest deluxe display rack system. Featuring an elegant and trend setting outlook and the highest weight-bearing capacity of any comparable rack on the market. It is highly stable and easy to assemble and take apart. Shelves can be mounted flat or at an angle. Many different color combinations are available to emphasize and highlight your luxury goods.

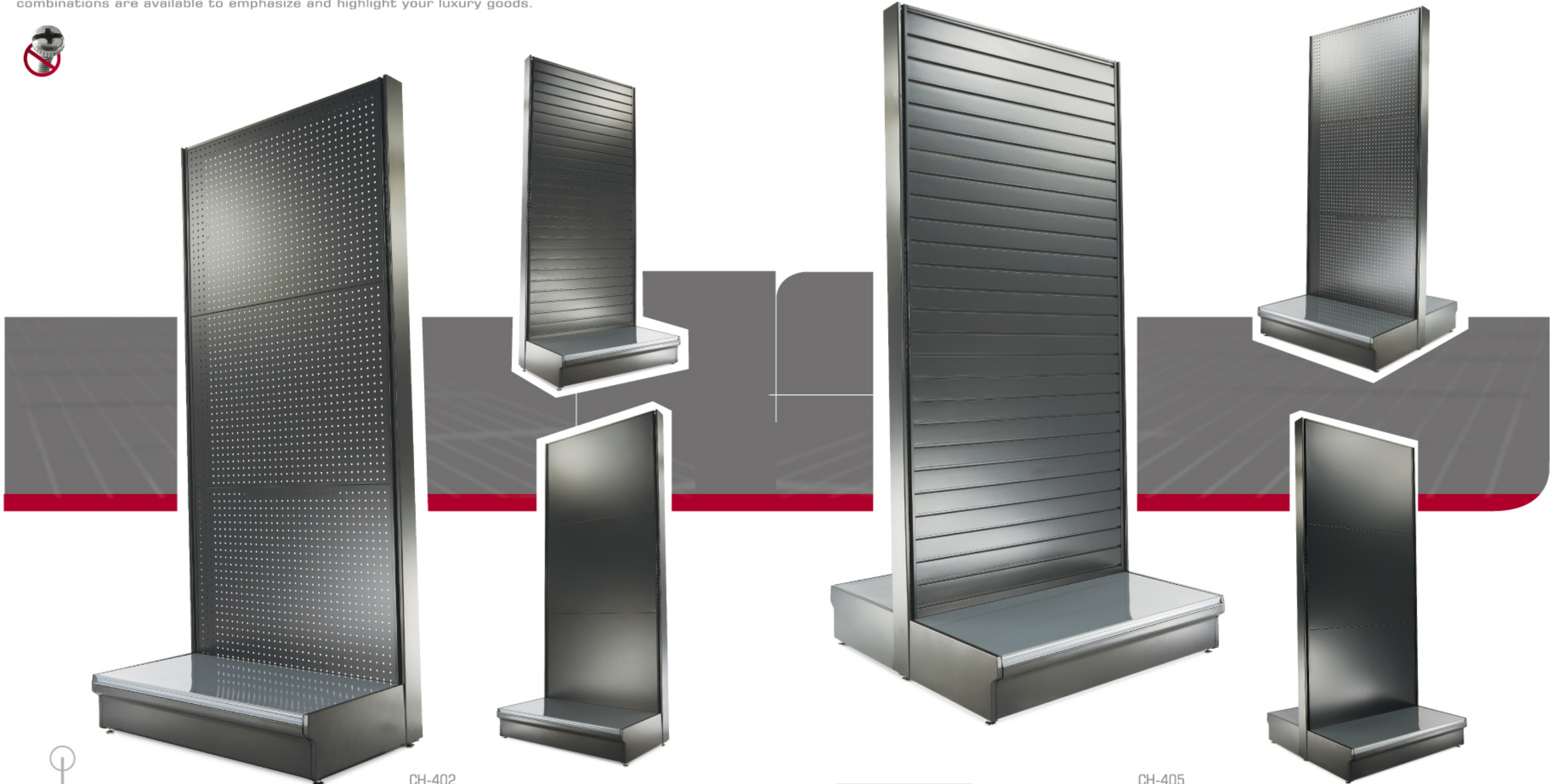

CH-402
 Size:
 H: 1420, 1510, 1800, 2100, 2400mm
 W: 700, 945, 1000, 1245mm (Single Unit)
 W: 685, 930, 985, 1230mm (Conjoin Unit)
 D: 450, 500, 600mm



CH-405
 Size:
 H: 1420, 1510, 1770, 2070, 2370mm
 W: 700, 945, 1000, 1245mm (Single Unit)
 W: 685, 930, 985, 1230mm (Conjoin Unit)
 D: 450, 500, 600mm

CH-Series; Heavy Duty: Corner options

Retail space can sometimes be limited to small areas. Cheng Chia racks can also fit into tight corners with its corner-rack system, allowing for maximum space optimization.

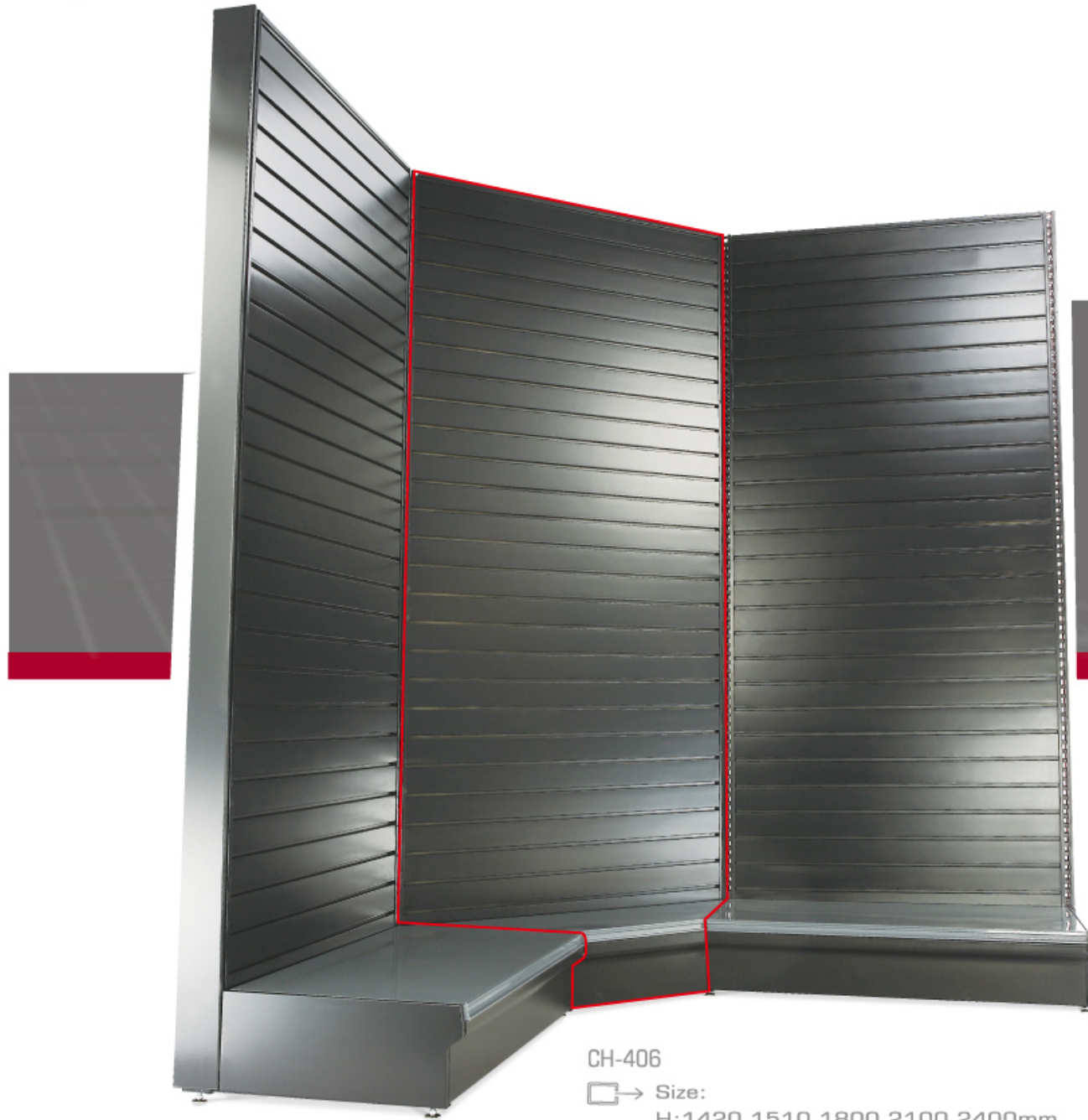

CH-406

 Size:
H: 1420, 1510, 1800, 2100, 2400mm
W: 1000mm
D: 450, 500, 600mm

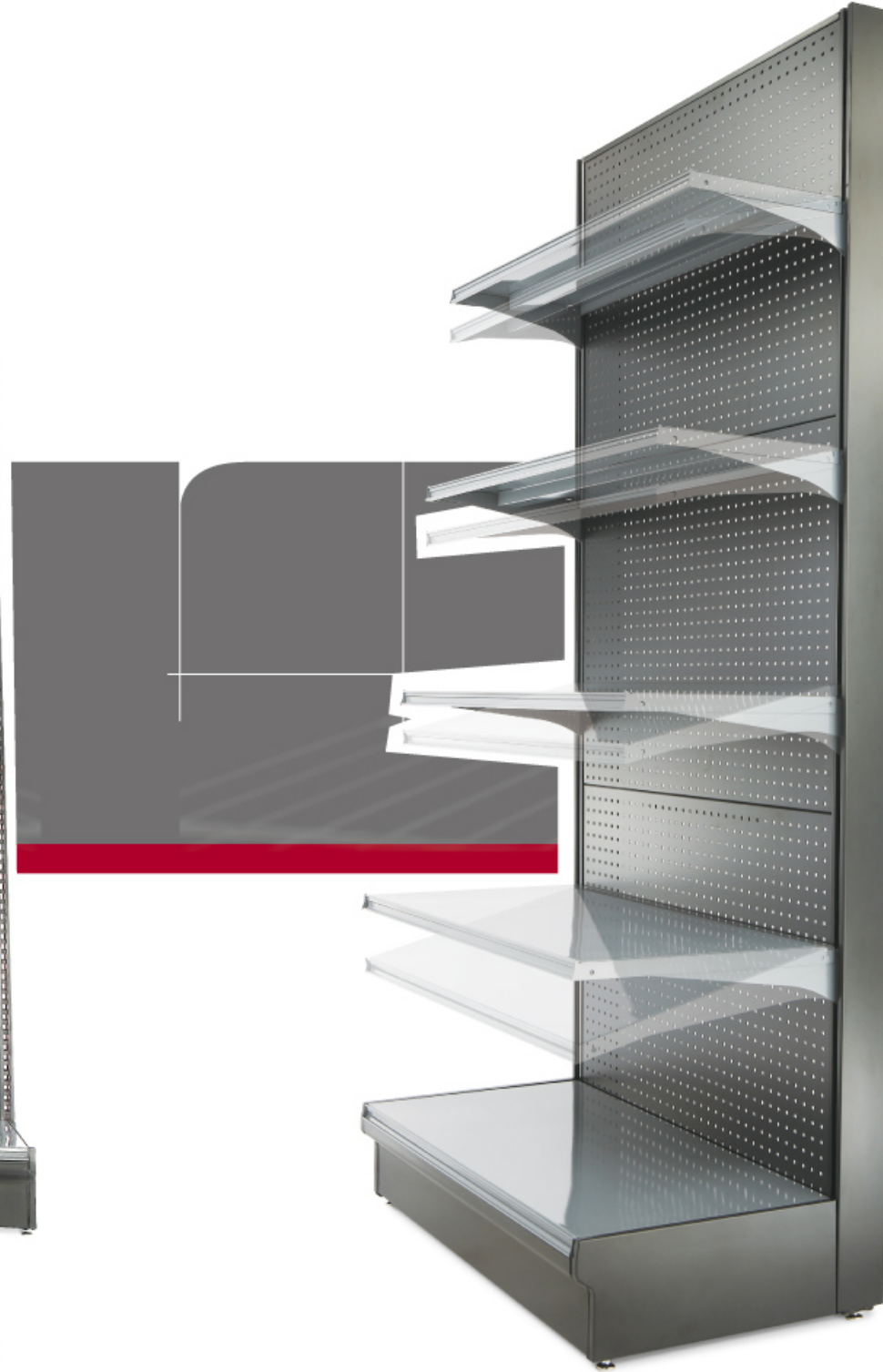

CHS-2
W: 700, 945, 1000, 1245mm
D: 300, 350, 400, 450, 500, 600mm
H: 30mm
T: 0.8mm
Loading: 120kgs each layer

CH-Series; Heavy Duty: Shelves, cabinets and logo panels

This display rack is so versatile that shelves can be assembled at different heights and angles and large multiple function storage cabinets sit perfectly on the rack base. Our attractive storage cabinets are built to withstand heavy weights and come in different shapes and sizes. Furthermore, to highlight the product types or product brands, Cheng Chia offers a practical range of Logo panels to suit individual requirements and preferences. From Logo light boxes, slot logo panels to poster style logo panels, Cheng Chia has thought of everything.



CHB-1

Size:
W: 700, 945, 1000, 1245mm
D: 450, 500, 600mm
H: 500mm



CHB-2

Size:
W: 700, 945, 1000, 1245mm
D: 450, 500, 600mm
H: 500mm



CH-L13

Size:
W: 700, 945, 1000, 1245mm
H: 300mm



CH-L12

Size:
W: 700, 945, 1000, 1245mm
H: 200, 300, 350, 400mm



CH-Series: Light Boxes

Cheng Chia's Logo light box series come in different thicknesses and help illuminate the product and/or brand name, making them noticeable in crowded places. Colors become vibrant and the display rack stands out from others.

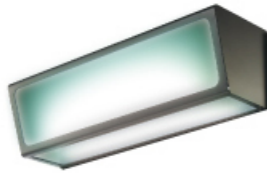
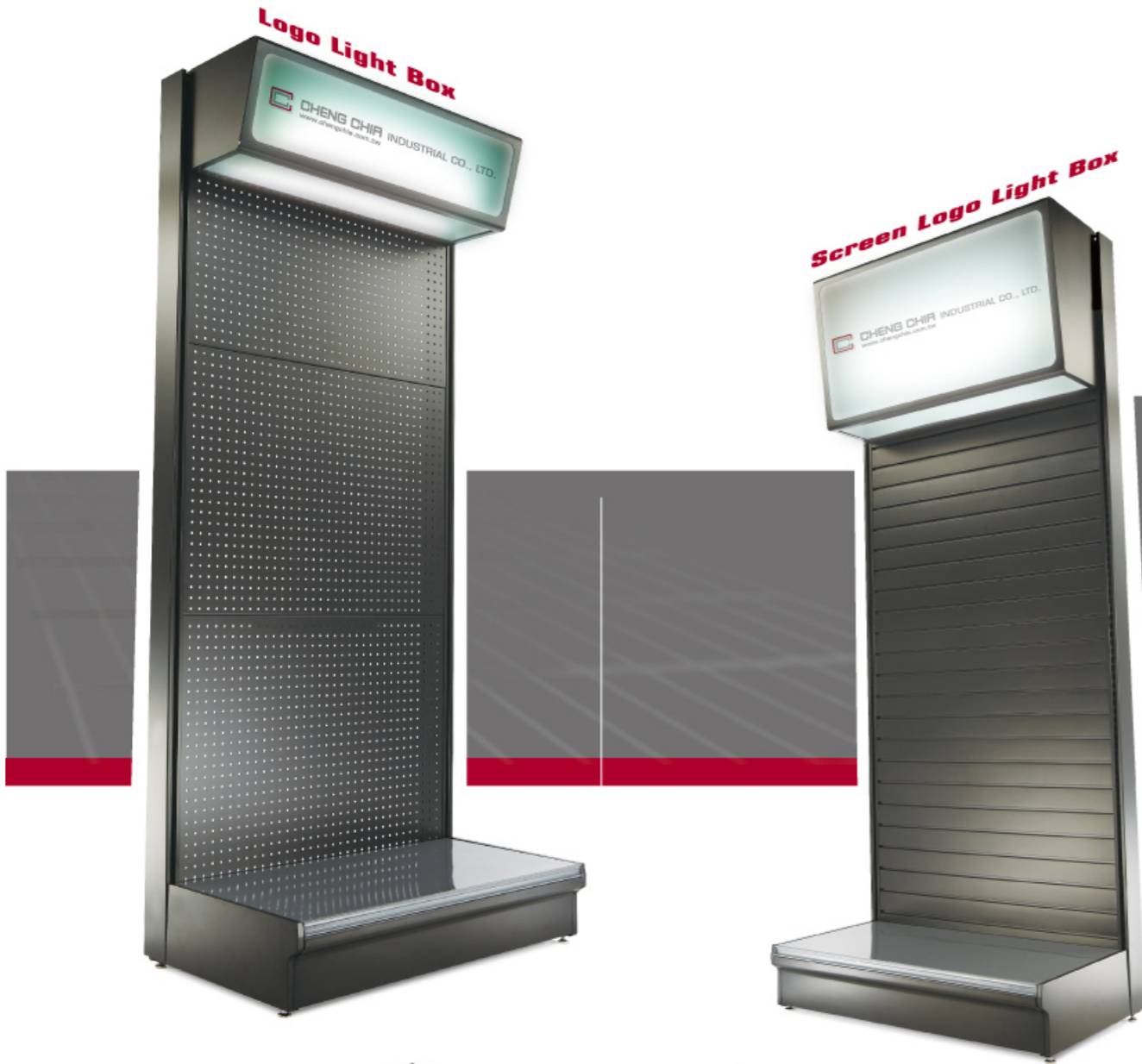

CH-L10
 Size:
 W: 700, 945, 1000, 1245mm
 H: 250mm
 D: 270mm



CH-L11
 Size:
 W: 700, 945, 1000, 1245mm
 H: 500mm
 D: 270mm

Accessories

CH-906



Size:
 \varnothing : 4mm
 L: 50, 100, 150, 200, 250, 300mm

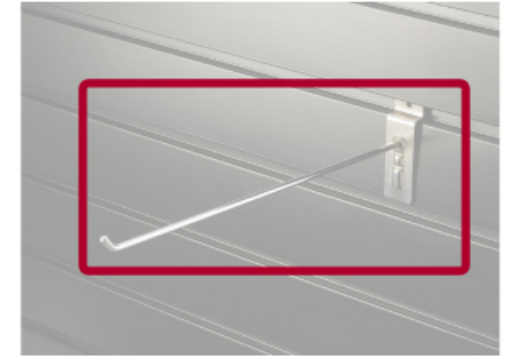

All hooks are available with electro-plated or enamel finish. We welcome requests for custom hook styles and dimensions.

CH-905

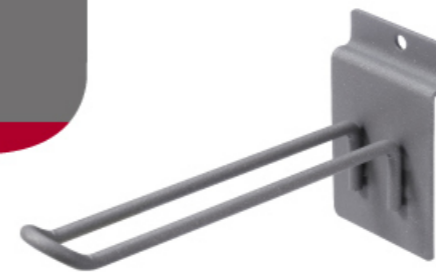

Size:
 \varnothing : 4mm
 L: 50, 100, 150, 200, 250, 300mm

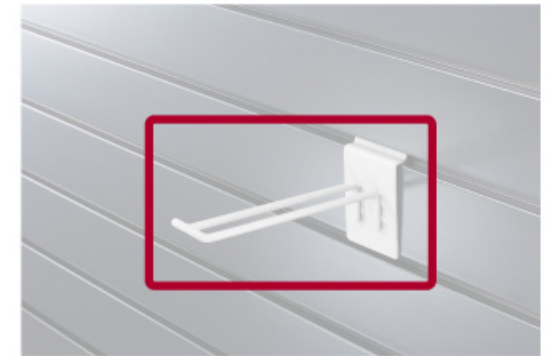

CH-907

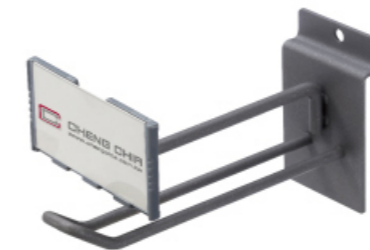

Size:
 \varnothing : 4mm
 L: 50, 100, 150, 200, 250, 300mm
 Price Tag : w 40, 70mm



All hooks are available with electro-plated or enamel finish. We welcome requests for custom hook styles and dimensions.

Accessories



CH-908

CH-926



Size:
 \varnothing : 6mm
 L: 50, 100, 150, 200, 250, 300mm

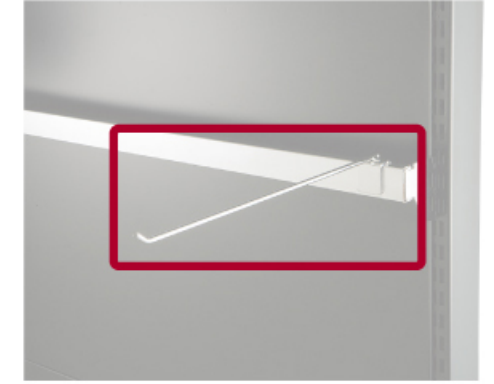

CH-900

Size:
 W: 700, 945, 1000, 1245mm



CH-930



Price Tag : w 40, 70mm



Size:
 \varnothing : 4mm
 L: 100, 200, 300mm



CH-923

Size:
 TUBE: T1.2x20x20mm
 D: 300, 400mm

CH-921



Size:
 D: 400mm

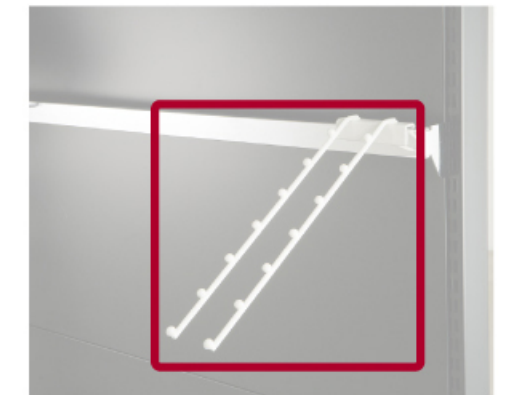

All hooks are available with electro-plated or enamel finish. We welcome requests for custom hook styles and dimensions.

Accessories

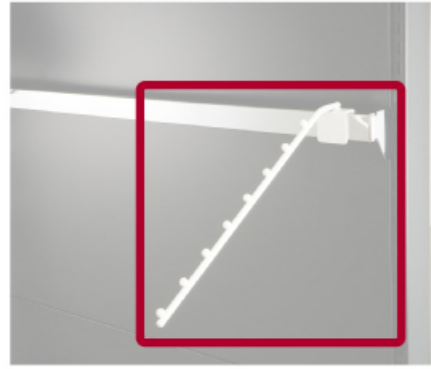

Size:
D:400mm

CH-922

CH-934



Size:
T:1.2mm
D:300,350,400,450

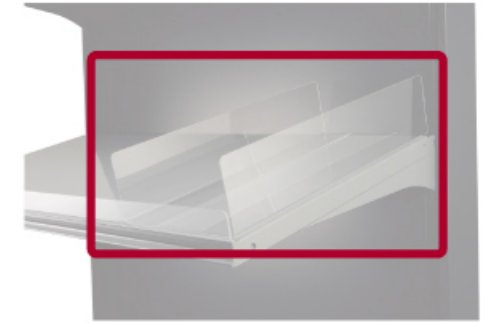

Size:
W:700,945,1000,1245mm
H:60mm



CH-917



**Price Label
CH-918**

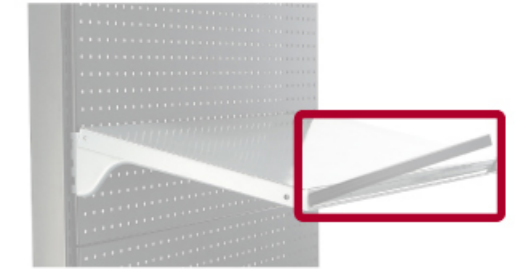

Size:
ø: 4.8mm
L:100,200,300mm



Size:
W:700,945,1000,1245mm
H:40mm

CH-933

CH-909



Size:
D:70mm



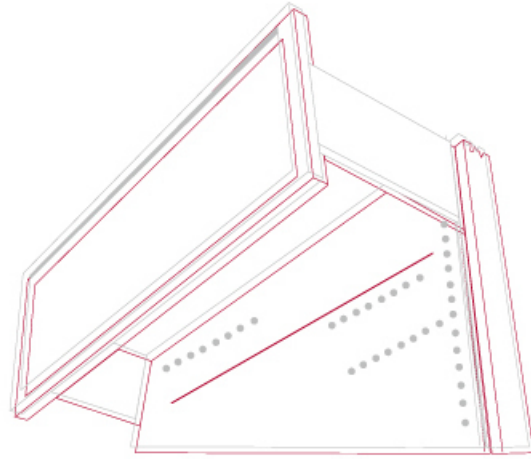

CHENG CHIA
Product catalogue

Storage



Storage Rack

This storage rack features attractive styling and a high weight-bearing capacity. It is easy to assemble and is not prone to swaying. The shelves can be moved up and down to match display needs. Needs no screws; assembly and disassembly are convenient and hassle-free. Can be set up in many different arrangements. Very suitable for stock storage and display at mass merchants and warehouses.

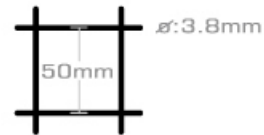

C-701

Size:
H: 1510, 1800, 2100, 2400mm
W: 945, 1245mm
D: 450, 600mm
Loading: Light Duty 150kgs each layer
Heavy Duty 180kgs each layer



C-702

Size:
H: 1510, 1800, 2100, 2400mm
W: 945, 1245mm
D: 900, 1200mm
Loading: Light Duty 150kgs each layer
Heavy Duty 180kgs each layer

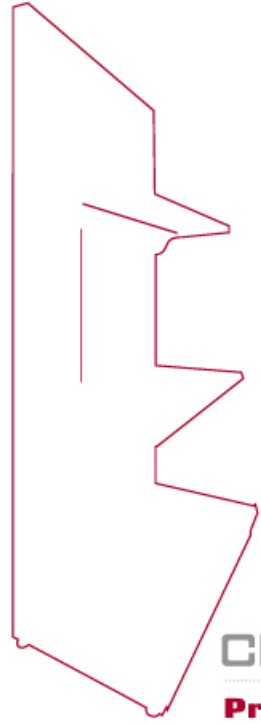

CHENG CHIA
Product catalogue

Promotion



Light Duty Spinner

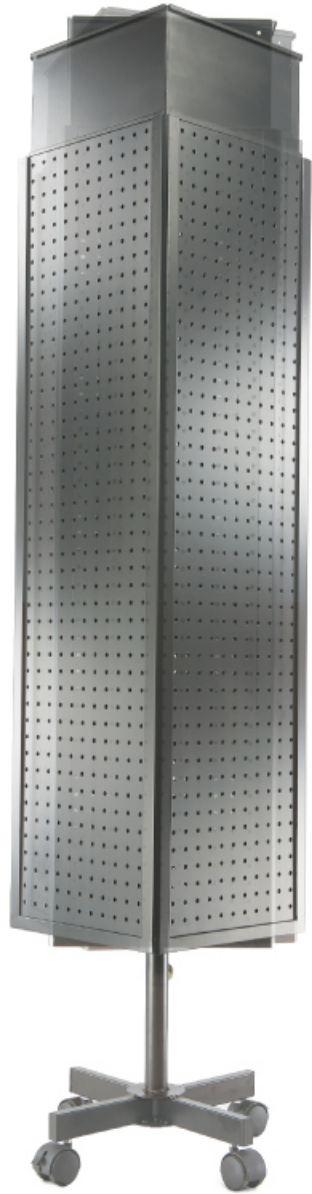

C-809
Size:
H:1715mm
W:330mm
D:330mm

Heavy Duty Spinner



C-820
Size:
H:1575mm
W:500mm
D:500mm

Z Type



C-810
Size:
H:1670mm
W:540mm
D:370mm

Multi-Function



C-817
Size:
H:1800, 2100mm
W:450, 600mm
D:400mm



Commercial Type



C-808
Size:
H:1440mm
W:655mm
D:355mm

Multi-purpose



C-806
Size:
H:1450mm
W:920,620mm
D:300,350mm

Counter top



C-815
Size:
H:700mm
W:370mm
D:300mm



Socket Box

C-811
Size:
H:350mm
W:420mm
D:350mm

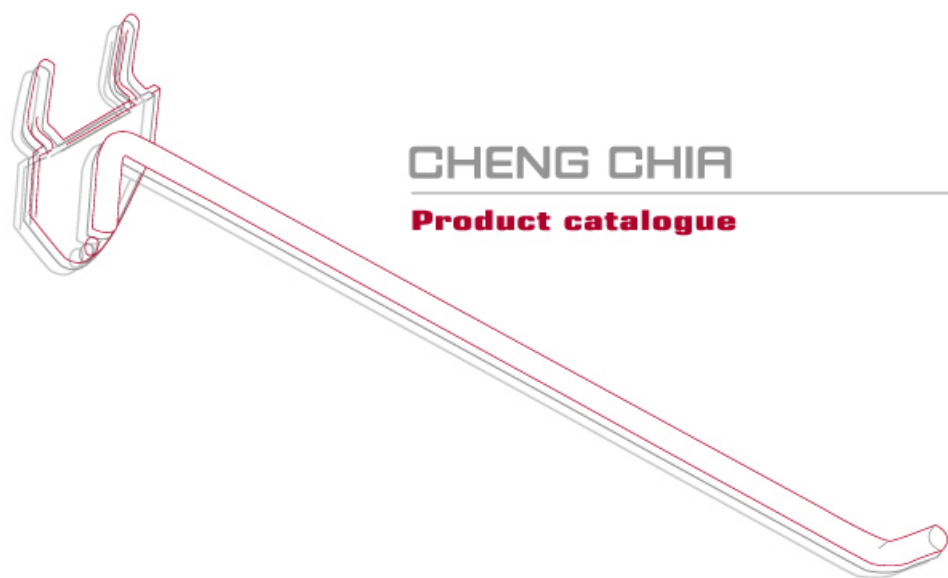

CHENG CHIA
Product catalogue

Custom made





Custom made

There is very little Cheng Chia doesn't do. As an integral part of the business' structure, Cheng Chia implements a Customer Service System which leaves nothing unattended; short lead-time OEM and ODM solutions, unique customized designs, rapid mock-up sample fabrication and shipping logistics. These services give the clients freedom to request intricate designs whatever the size, colour and style they may need.

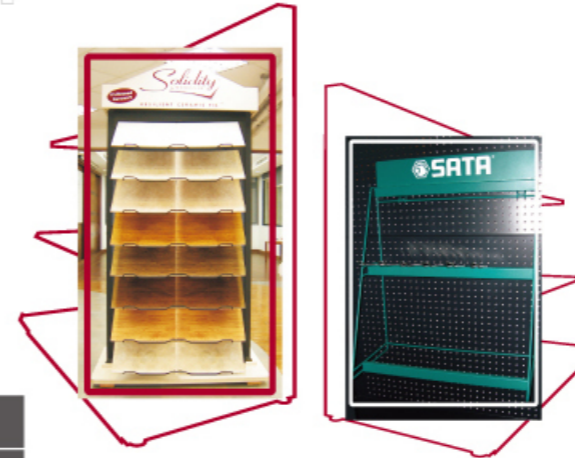

→ INSTALLATION MANUAL

NC Series

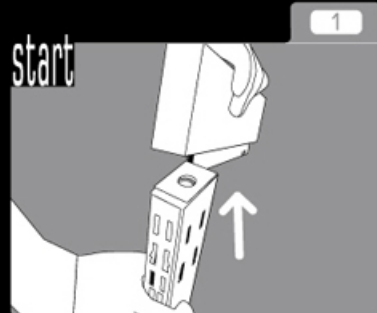
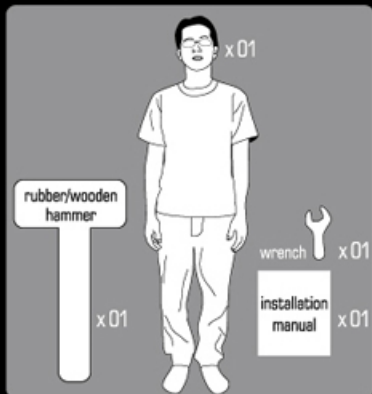

start
Push the pillar into the hole in the end of the base.

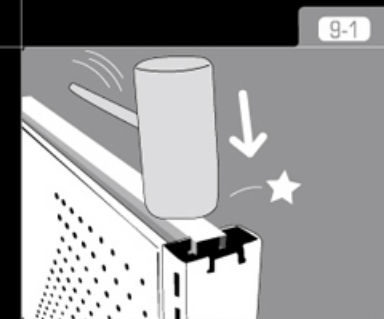
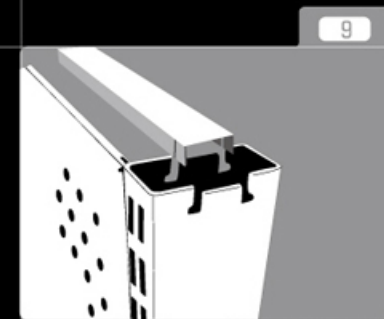
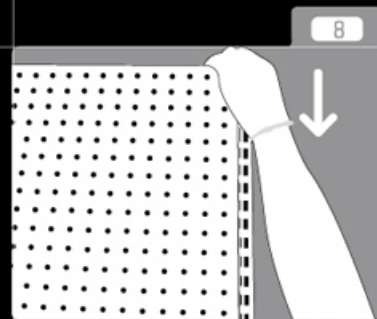
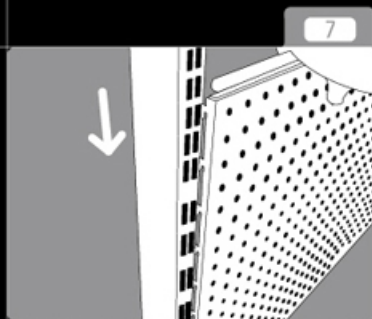
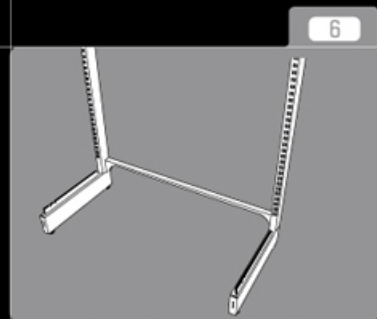
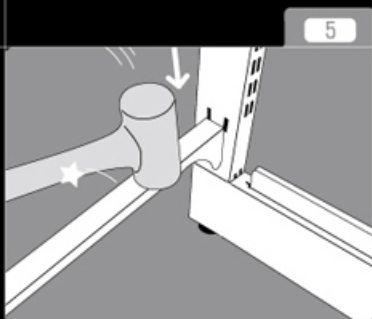
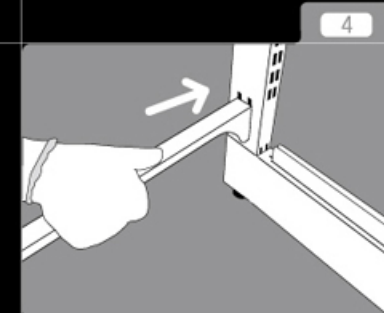
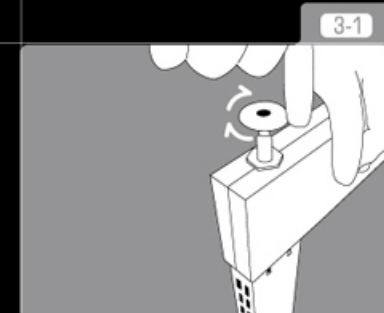
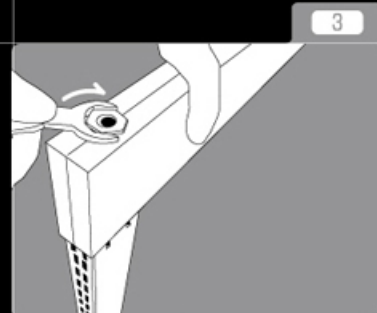
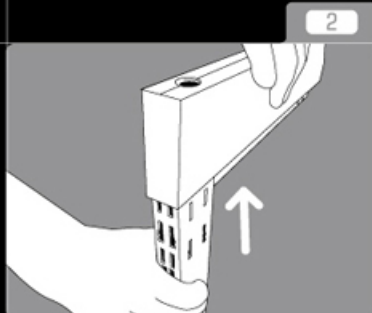

Schematic diagram of completed feet and lower assembly.

To install panel, put base into position first. Insert the panel into the row of holes in the pillar at one end, and use the same method to lock the other end.

Install the top of the panel as shown in Fig. 5.

Upper assembly: Push one end of the upper connector into the gap at the end of the pillar until locked into place. Install the other end the same way.

The tenons must be tightly inserted to ensure that the completed rack is as stable as possible. Use a rubber or wooden mallet to tap the tenons into place.

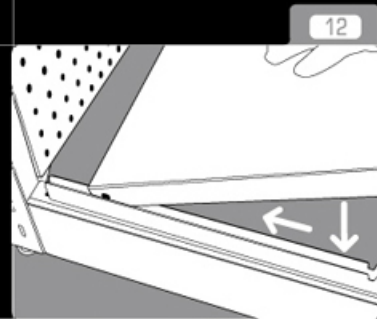
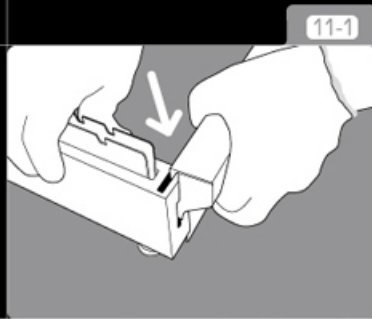
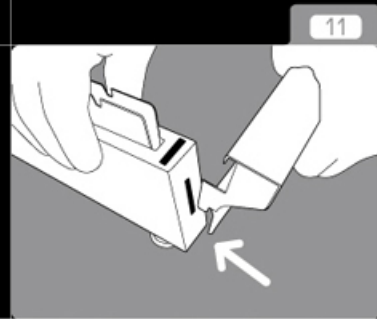
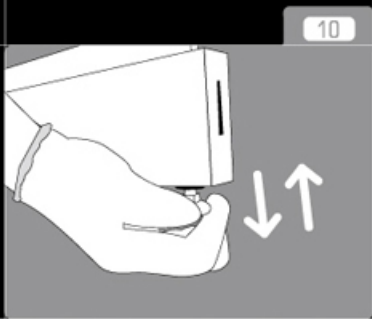

The knob on the front of the base can be used to adjust the display rack's center of gravity and horizontal angle.

To install the front panel, firmly hold one end and insert the hanger on it. Lift the hole on the front of the base up until tight and press down to lock.

Press the upper hanger down in the direction of the arrow, and simultaneously lock into the elongated hole on the top of the base.

To install the lower panel, hold it by its front edge with both hands and lift up so that the back end faces down. Lock the panels on both ends into the inner groove on the base, push back, and then push down until level.

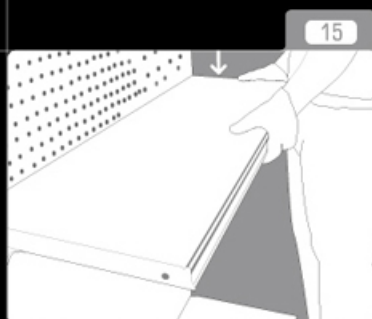
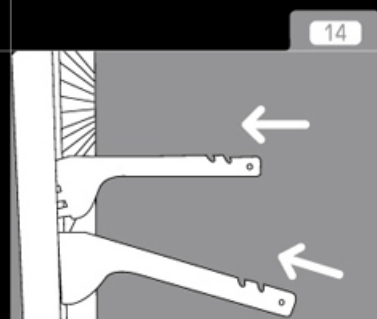
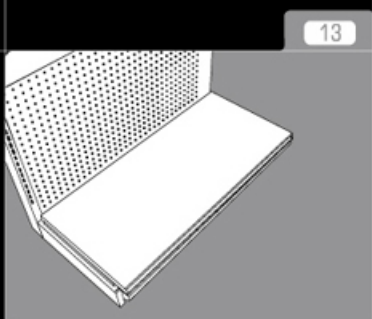
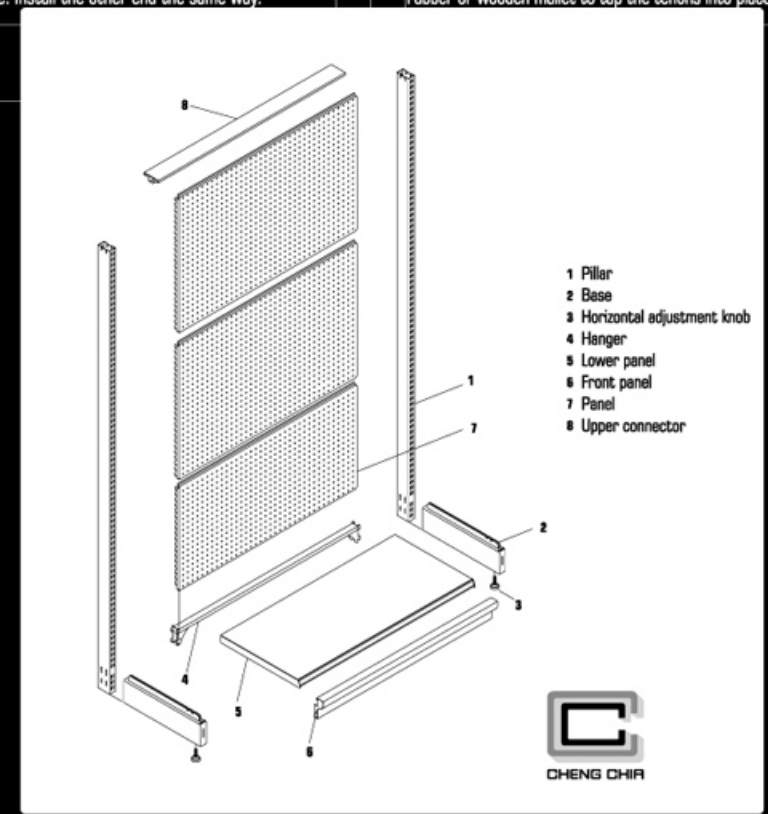

Completed bottom panel.

To install handles, push forward into desired holes, and then press down to lock in a horizontal or angled position.

Lift the front of the shelf up until roughly at a 45° angle. Lock the inner side of the panel on the back edge of the shelf onto the outer edge of the handle. Push down and check whether the tenons on the back edge of the shelf have locked into five grooves on the handle.



→ INSTALLATION MANUAL CH Series

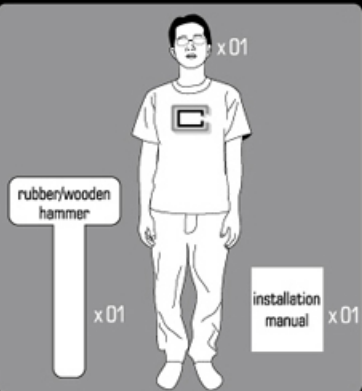

1

start

Insert the leveller screws all the way into the threaded holes in the foot stand plates.
Note: Ensure that the display rack is level when assembly of the framework is complete.

2

Put the pillars in place; use one hand to insert the hooks on the back of the lower anchor into the holes near the bottom of the pillar and push down to lock.

2-1

To prevent the anchor from becoming loose, ensure that the two angled attachment tabs above the hooks firmly hold the pillar in place.
Note: Use a hammer to tap the anchor into place for firm assembly.

2-2

IMPORTANT !

3

Insert the hooks at one end of the foot stand plate tightly into the holes on the side of the pillar and push down to lock into place.

3-1

4

A central anchor is needed when the pillars are too tall. After installing the foot stand plates, insert the central anchor into the mountings in the middle of the pillars and push down to lock into place.

5

To install the slat wall's central back pillar, insert the bottom of the pillar into the slot in the foot stand plates.

5-1

6

To install the back panel (either slat wall or pegboard) push the two sides of the pre-installed back panel into the grooves in the pillars in an upwards direction and then push down to lock into place.

7

After installing the back panel, insert the hooks on one end of the upper anchor into the slots at the top of a pillar; repeat with the other pillar and use a hammer to tap the hooks firmly into place.

8

To install the base front, put the holes on one end of the base front over the hooks on one foot stand plate and push down to lock into place; install the other end the same way.

8-1

Make sure that the hooks on the top of the base front are firmly inserted into the holes on top of the foot stand plates when installing the other end of the base front.

9

The display rack framework is now complete.

10

To install the base shelf, hold the front of the base shelf with both hands, lift the shelf up at a 45° angle and insert the plate at the back of the base shelf into the groove in the lower anchor until it clicks into place. Place the back panel in a horizontal position and make sure the tenons at the back of the shelf are securely fastened into the S-shaped holes in the anchor.

11

To install the pillar side covers, insert the hooks inside the side covers into the holes in the pillars and push down to lock into place.

11-1

12

To install the base side plates, place them on the foot stand plates, and insert the hooks at the front of the side plates into the holes used to attach the base front. Insert the lips on the pillar side covers into the grooves in the anchors and push down to lock into place.

12-1

13

Put the shelf brackets in place. Insert the shelf brackets into the desired holes and push down to lock the hooks into place.

13-1

14

Put the shelves in place. Hold up the front edge of the shelves roughly at a 45° angle and position the side plates on both sides of the shelves over the outsides of the brackets; lower the shelves into position and make sure the tenons are in place.

finish

EASY!

